



Features

High power performance
Low ESR
Over 1,000,000 duty cycles
Laser weldable terminals

Applications

Pitching control system of Wind Turbine Generator
EV/HEV
Solar energy conversion system
Hybrid drive trains
Mass transportation braking energy recovery system
UPS/DVC
Heavy duty machinery
Locomotive engine startup system



Dimension

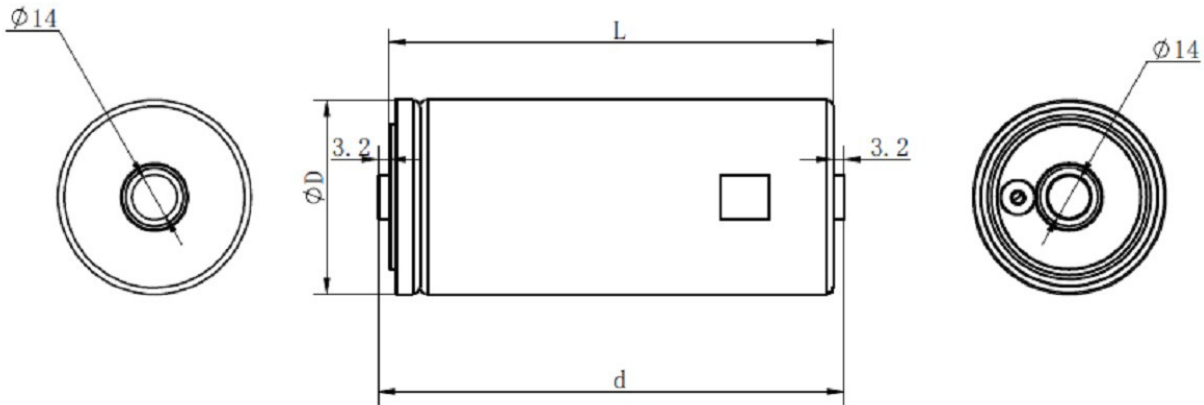

Dimension(mm)					
GT Part Number	Voltage	Capacitance	D (Max)	L(±0.3)	d(±0.5)
GTSP-2R7-657UW	2.7V	650F	60.8	51.5	57.9
GTSP-2R7-128UW	2.7V	1200F	60.8	74	80.4
GTSP-2R7-158UW	2.7V	1500F	60.8	85	91.4
GTSP-2R7-208UW	2.7V	2000F	60.8	102	108.4
GTSP-2R7-308UW	2.7V	3000F	60.8	138	144.4
GTSP-2R7-508UW	2.7V	5000F	60.8	203.5	210

Specifications

Capacitance (F)	Voltage(V/DC)	Maximum ESR (mΩ)		Max. Continuous Current (A)	Max. Peak Current (A)	Leakage Current (mA) @ 25°C after 72 Hours	Max. Energy Stored (Wh)	Max. Energy Density (Wh/Kg)	Weight (g)
		AC @ 1kHz	DC						
650	2.7	0.6	0.8	65	580	1.8	0.66	2.86	230
1200	2.7	0.40	0.47	85	1035	2.5	1.22	4.05	300
1500	2.7	0.33	0.41	100	1253	3.0	1.52	4.60	330
2000	2.7	0.25	0.32	125	1646	3.5	2.03	5.06	400
3000	2.7	0.22	0.26	150	2275	5.2	3.04	5.73	530
5000	2.7	0.21	0.23	250	3139	8.0	5.06	6.33	800



Working Voltage	2.7 VDC
Surge Voltage	2.85 VDC
Capacitance Tolerance	-10% to +20% (25°C)
Operating Temperature Range	-40°C to 65°C, ΔC<20%, ΔESR<50% of initial measured value@ 25°C
Storage Temperature Range	-40°C to 70°C
Life (1500hrs @ 85°C @ 2.65V DC)	ΔC<30% of initial measured value, ΔESR<100% of specified value
storage(2 years @ 70°C ,without loading)	ΔC<30% of initial measured value, ΔESR<100% of specified value

Install method

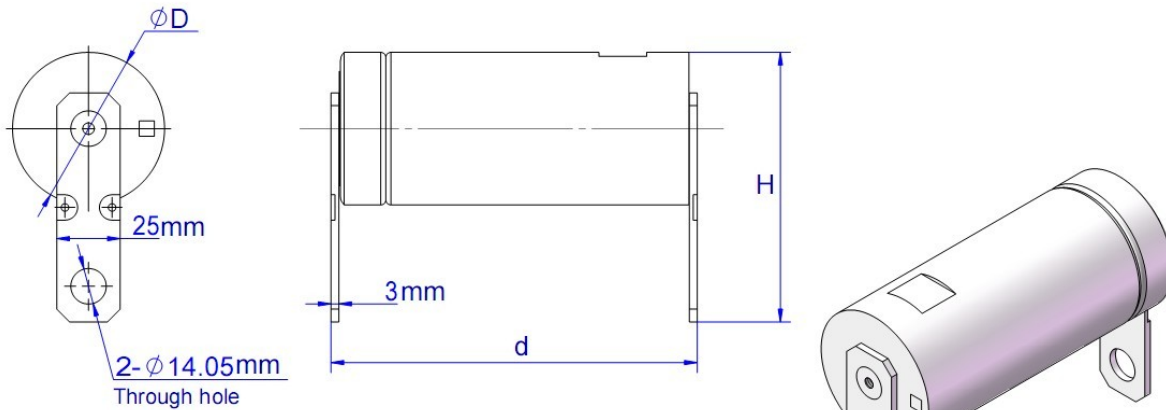

Dimension(mm)				
Capacitance	D (Max)	L(± 0.3)	d(± 0.5)	H(± 0.5)
650F	60.8	51.5	57.9	106
1200F	60.8	74	80.4	106
1500F	60.8	85	91.4	106
2000F	60.8	102	108.4	106
3000F	60.8	138	144.4	106
5000F	60.8	203.5	210	106

Laser welding terminals is designed by Green Tech develop & research department.

It has many advantages compare with screw terminals.

- 1) Extremely small ESR and Lower leakage current;
- 2) Larger peak current because ESR smaller and the terminals can load larger current;
- 3) Reduce straight shake to the electrodes, then avoided weeping;
- 4) Welder laser make it firmer and stable.
- 5) You can free to connect the capacitors in series or in parallel with the connect plates.
- 6) Connect plates and laser welding service offer if requested.(We suggest to install a balance circuit when making modules)
- 7) **Note:** connect plate cost 3.3USD/pair,you can buy from local market also.

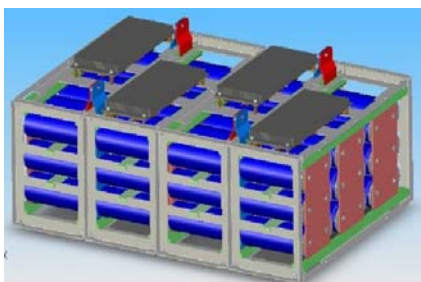



Curve of performance testing

Temperature character:

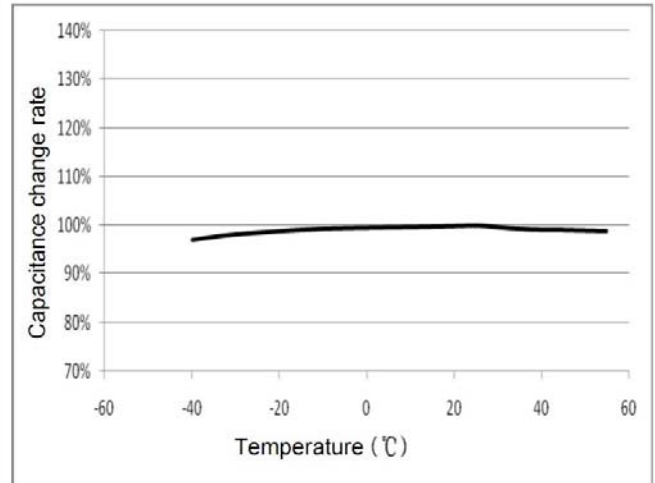
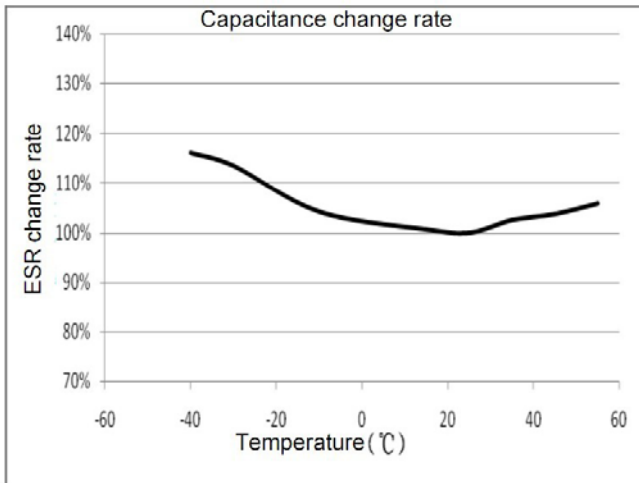

Life character test:

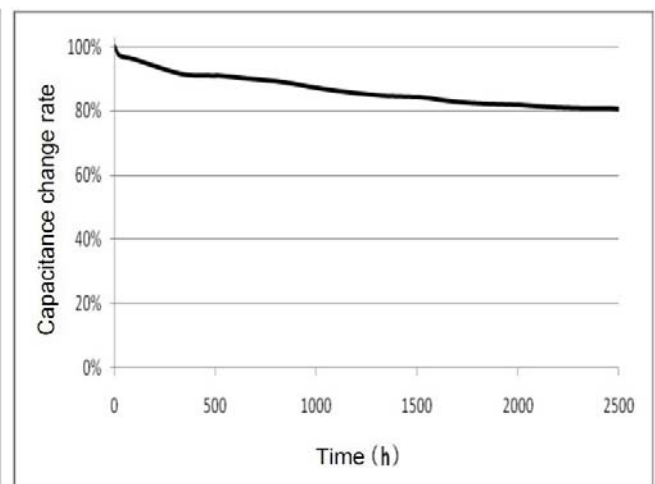
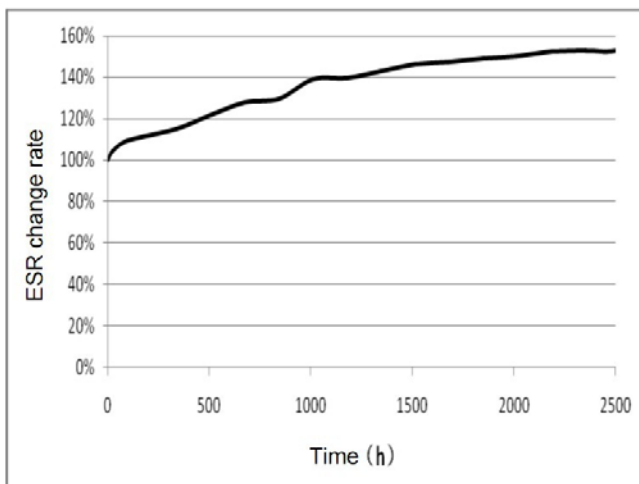

Leakage current,charge&discharge character

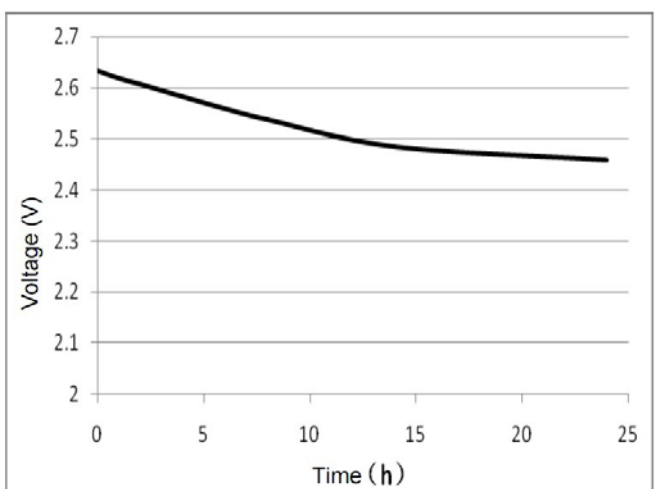
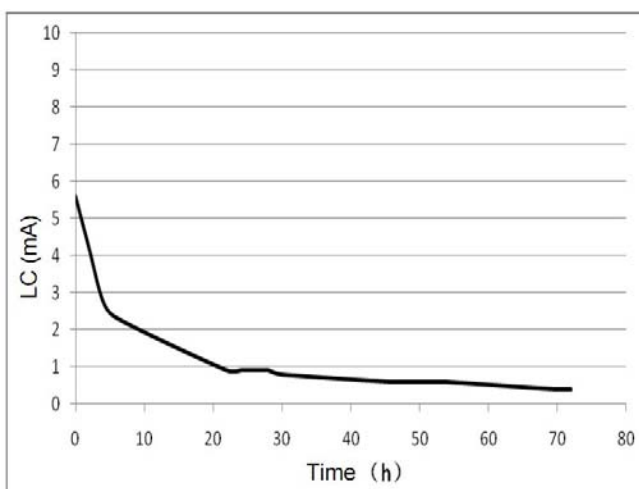



Charge&discharge cycle character

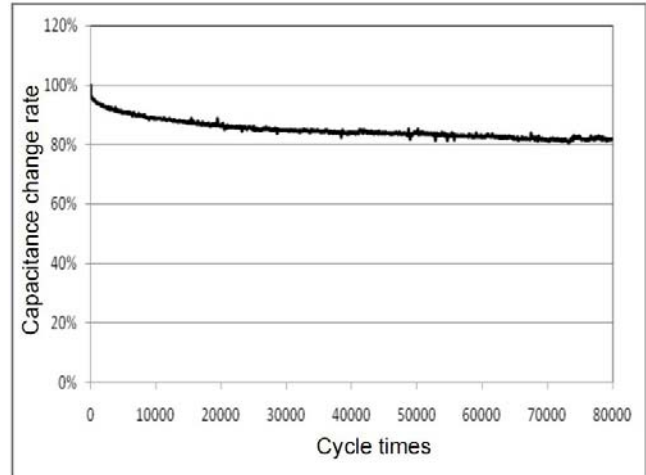
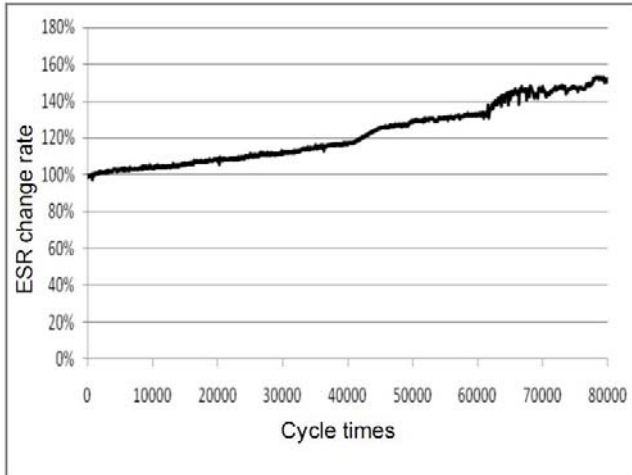

Store life character

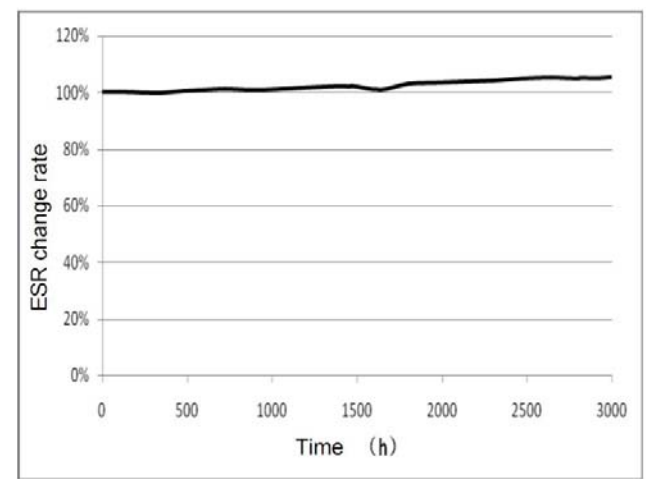
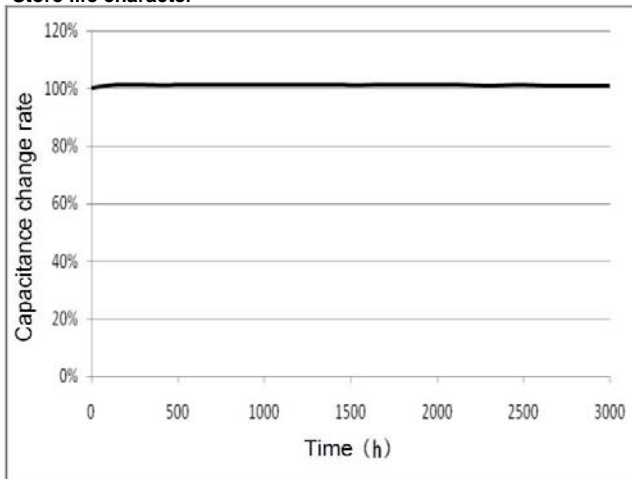

GT Part NO.

Brand	Super capacitor	Series	Rated Voltage		Capacitance		Tolerance		Terminal Type		
Code	Series	Code	Voltage	Code	Value (F)	Code	Tolerance	Code	Terminal		
GT	S										
Green Tech		P	Power	2R5	2.5V	104	0.1	J	±5%	H	Horizontal
		E	Energy	2R7	2.7V	224	0.22	K	±10%	V	Vertical
		M	Module	3R3	3.3V	334	0.33	M	±20%	C	Coin
		PH	Hi-Temp P	5R0	5.0V	474	0.47	U	-10%~20%	R	Radial
		EH	Hi-Temp E	5R5	5.5V	105	1.0	V	10%~30%	T	Thread
		MH	Hi-temp M	6R3	6.3V	155	1.5	Z	-20%~80%	N	Snap in
		PP	Big Power	012	12V	205	2.0			W	Weldable
		ML	Military	016	16V	335	3.3			P	Pillar
				024	24V	475	4.7			S	Screw in
				036	36V	805	8.0			L	Wire
				048	48V	106	10				
				056	56V	206	20				
				075	75V	306	30				
				100	100V	506	50				
				120	120V	107	100				
				240	240V	158	1500				
						308	3000				
						508	5000				
						728	7200				